

4. Costs associated with:

- Product removal
- Brand label removal
- Product reinstallation
- Incidentals or consequential damages
- Transportation to/from the retailer
- Product re-measure
- Shipping

In the event there are multiple blinds/shades in the same room, only the defective blind/shade will be replaced.

To Report Shipping Damage: If damage occurred during shipping, call the place of purchase and report within 7 calendar days, or you may be denied credit for your damaged product.

To Obtain Service: If you suspect this product has a manufacturing defect in materials or workmanship:

- Locate the sales receipt
- Call place of purchase

Any unauthorized returns will not be accepted.

Warranty Remedy: This shall be your sole remedy under this limited warranty. If this product is found to have a manufacturing defect in materials or workmanship, we will, at our discretion, do one of the following:

- Repair the product
- Replace the product
- Refund the cost of the product.

Colors may vary from lot to lot and may not exactly match sample swatches or previous purchases.

Discontinued items or color selections will be replaced with the closest equivalent current product.

Your rights under state law: This lifetime limited warranty gives you specific legal rights, and you may have other rights which vary from state to state. Some states do not allow limitations on how long a warranty lasts, so the above limitations may not apply to you. No agent, representative, dealer or unauthorized employee has the authority to increase or alter the obligation of this warranty. This lifetime limited warranty supersedes any previous versions.

Banded Fabric Loop Roller Shade

INSTALLATION INSTRUCTIONS

Step 1. Check Package Contents

Missing part? Call 1-800-264-1190
Mounting hardware kit includes the following:

Part	Quantity
a. Mounting Brackets	2 shades up to 45" wide 3 up to 72" wide 4 up to 94" wide
b. Extension Brackets (for outside mounts)	2 shades up to 45" wide 3 up to 72" wide 4 up to 94" wide
c. Screws	4 shades up to 45" wide 6 up to 72" wide 8 up to 94" wide
d. Wall Anchors	4 shades up to 45" wide 6 up to 72" wide 8 up to 94" wide

Step 2. Tools Required

Pencil, tape measure, level, screw driver, pliers, step stool, drill.

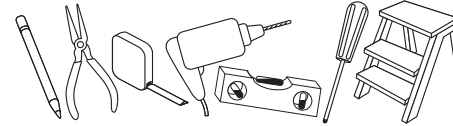

Step 3. Installation

Your blind may be installed either inside the window frame or outside the window frame.

Wallboard or Plaster: use wall anchors.
Concrete, Stone, Brick: use a masonry drill bit and anchors or screws specifically designed for masonry (not included).

Inside Mounting:

One bracket should be positioned about 2" to 6" from each end of the head rail. For wider shades that require 3 or 4 brackets, these should be spaced evenly between the two outermost brackets.

Attach each bracket to the inner top of the window opening using the screws provided. Pre-drill the screw holes using a 5/64" drill bit. The extension brackets are not used for inside mounts.

For flush inside mounts, attach the

brackets to the head rail first (see drawings and attachment instructions below), and then position the shade in the window opening as desired. Then make pencil marks at the back of each bracket. Remove the brackets by pressing on the plastic tab. Align the brackets with the pencil marks, and then screw them in place as described above.

Outside Mounting:

Attach the Extension Brackets to the wall or window framing. One bracket should be positioned about 2" to 6" from each end of the head rail. For wider shades that require 3 or 4 brackets, these should be spaced evenly between the two outermost brackets. Pre-drill the screw holes using a 5/64" drill bit.

The brackets must be level – use a Spirit Level if necessary to assure proper alignment.

Then attach a Mounting Bracket to each Extension Bracket using the nut and bolt pre-attached to each Extension Bracket.

To adjust head rail extension, remove the shade from the mounting brackets by pressing on the plastic tabs at the front of each bracket. Then loosen the nut and bolt, and move the mounting brackets forward or backward as preferred.

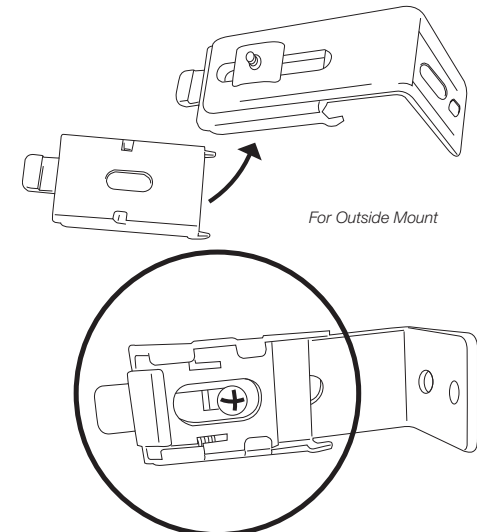

Step 4. Securing the Head Rail

Slide the inner rear of the head rail onto the metal tabs at the back of each bracket, and then push up so that the brackets snap onto the head rail.

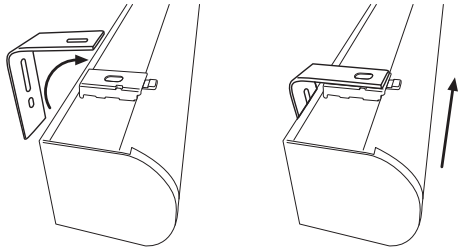

IMPORTANT FINAL STEP TO PROPERLY SECURE BRACKETS:

pull the plastic tab on the front of each bracket outward toward the front of the shade to lock the brackets in place. For inside-mounts use pliers to grasp the tabs. Check carefully to assure that each bracket is properly secured

Step 5. Install the Chain Tension Device

The tension device must be installed to make sure the shade is fully operable.

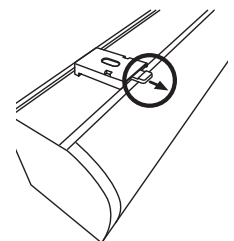
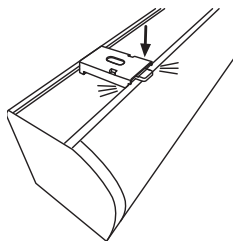
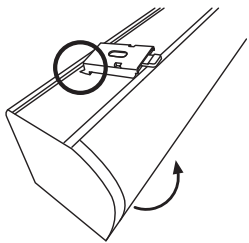

While holding the tension device in one hand, pull the plunger away from the bead chain with the other hand. Lift the bead chain out of the bead locking groove and slide the tension device to the bottom of the chain loop.

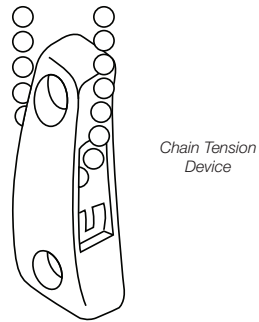

Pull the tension device down until the bead chain is fully tensioned (plunger will be at the top) and then move the tension device up approximately 1/8". Mark the screw hole locations on the wall with a pencil.

Inside Mount: if mounting into wood, pre-drill screw holes and then install the tension device using the 1/4" Phillips head screws provided.

If not securing into wood, use appropriate anchors for the substrate and follow anchor manufacturer's instructions.

Outside Mount: Align the mounting bracket screw holes with the pencil marks. If mounting into wood, pre-drill screw holes and then install the mounting

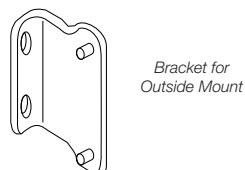
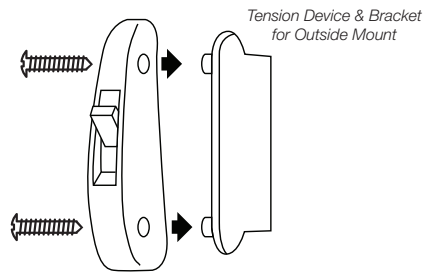

bracket using the 1/4" Phillips head screws provided.

If not securing into wood, use appropriate anchors for the substrate and follow manufacturer's instructions.

Press the tension device onto the mounting bracket posts. Carefully attach the Tension Device to the bracket using the 3/8" Phillips head screws provided.

DO NOT OVER-TIGHTEN.

Step 6. How to Operate

Pulling downward on the front or rear cord of the cord loop raises and lowers the shade. Always pull the cords slowly and evenly to maintain the optimal performance of your shade.

CLEANING

To clean the shade fabric, use a feather duster or vacuum lightly using the soft brush or upholstery attachment. For spot cleaning, use warm (not hot!) water with a mild soap to damp clean.

REPLACEMENT PARTS

In the event that replacement parts are ever needed, you may call: 1-800-264-1190 Please be sure to provide the following information, if possible:

- The complete model or catalog number of your product
- A description of the product
- A description of the part needed

LIMITED LIFETIME WARRANTY

The enclosed product is warranted to the original residential retail purchaser as long as the product remains in the original window.

Covered

Lifetime: Entire product against manufacturing defects (i.e. a flaw in the product design, materials, or workmanship that causes the product to no longer function.

3 Years: Cords, including internal cords such as those found in cordless blinds or shades.

5 Years: All fabric

Not Covered

1. Normal wear and Tear

2. Any product that fails due to:

- Abuse
- Exposure to salt air
- Improper installation
- Accident
- Extraordinary use
- Improper operation
- Alterations
- Improper cleaning
- Misapplication
- Damage from pests/insects/pets
- Improper handling
- Misuse

3. Natural Wood Products that have:

- Loss of color intensity
- Variations in color, grain or texture
- Warping of wood slats in high humidity areas